



"Connecting your **OK TODAY**
with an
Excellent Tomorrow"



3 IN 1 SS COMBINED

STAINLESS STEEL GANG BOX

PLUG TOPS

POWER STRIP (HEAVY DUTY)



ABOUT US

Our Mission:

“Innovating and bringing the future of electric based technologies to the world, with consistent advancement in the realms of quality and perfection”

About us:

At Lyter, we are on a constant mission to bring our customers the best in electric based technologies, and we do that with passion and constant innovation while keeping quality and simplicity at the core of user experience. From simple home based electric solutions to innovative world class technologies we are pushing the boundaries in the realms of electric technology manufacturing, innovation and customer experience to the next level. This is made possible by our world class manufacturing practices, innovation leadership, and dynamic control of our supply chain networks. We are proud to introduce to the world a new breed of electric solutions. We are confident and certain that our products will connect your world with the future of electric technology and user experience.

Our Vision:

To be the world reference in electrical and electronic based solutions.



NEW

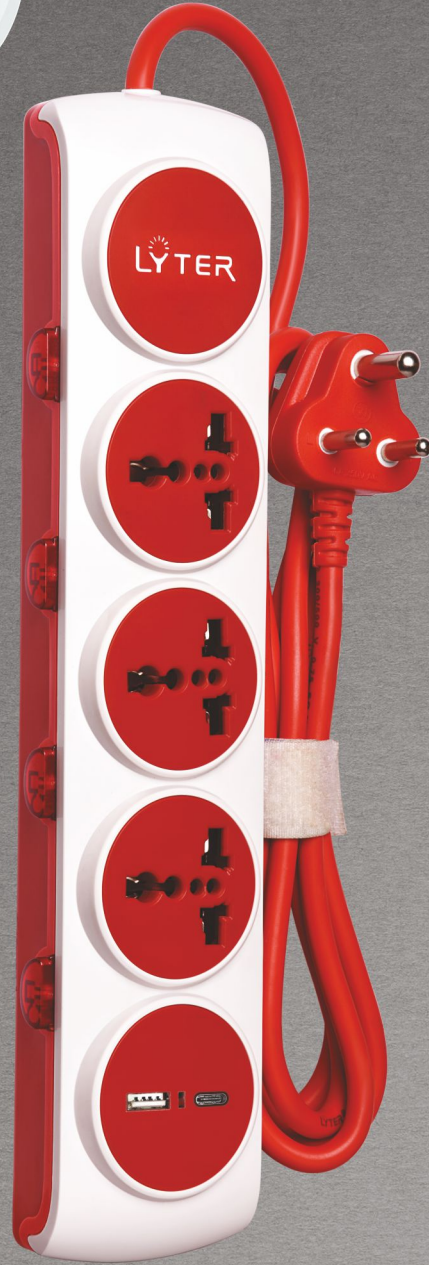
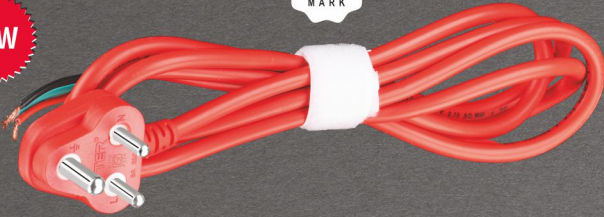

NEW

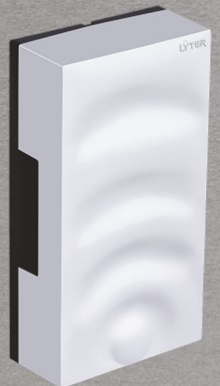



LR 1001

LR 1002

LR 1003



LR 1006

LR 1007

LR 1008



LR 1012

LR 1014

LR 1015



LR 1021

LR 1022

CODE PRODUCT

HSN
CODE

MRP
₹

STD/
MST
PKG.

LAMP ANGLE HOLDERS

LR 1001	Delux Angle Holder	85369090	47.00	20/480
LR 1002	Angle Holder Eco (Grill Type Skirt)	85369090	42.00	20/480
LR 1003	Ruby Angle Holder	85369090	47.00	20/480

LAMP BATTEN HOLDERS

LR 1006	Delux Batten Holder	85369090	47.00	20/480
LR 1007	Ruby Batten Holder	85369090	47.00	20/480
LR 1008	Batten Holder Eco (Grill Type Skirt)	85369090	42.00	20/480

PEARL LAMP ANGLE HOLDERS

LR 1012	Pearl Angle Holder Eco	85369090	53.00	20/480
LR 1014	Pearl Angle Holder Red	85369090	58.00	20/480
LR 1015	Pearl Angle Holder Orange	85369090	58.00	20/480

MARVEL LAMP ANGLE HOLDERS

LR 1021	Marvel Angle Holder	85369090	56.00	20/480
LR 1022	Marvel Angle Holder Eco	85369090	51.00	20/480

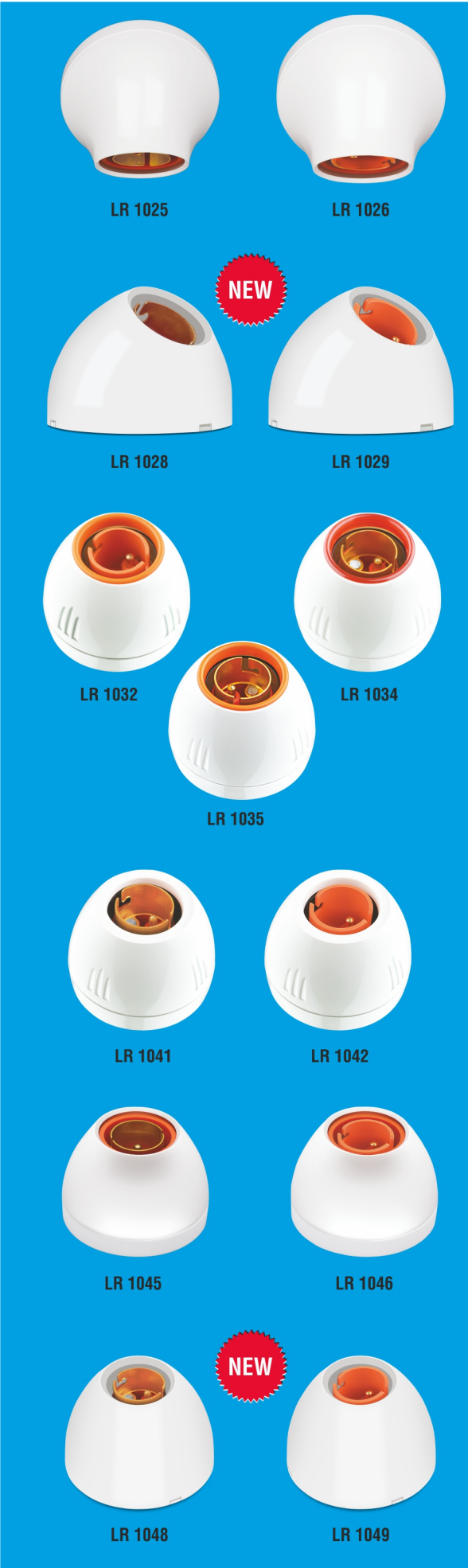

CODE	PRODUCT	HSN CODE	MRP ₹	STD/ MST/ PKG.
VENUS LAMP ANGLE HOLDERS				
LR 1025	Venus Angle Holder	85369090	51.00	20/480
LR 1026	Venus Angle Holder Eco	85369090	46.00	20/480
POLO MODULAR LAMP ANGLE HOLDERS				
LR 1028	Polo Modular Angle Holder	85369090	49.00	20/480
LR 1029	Polo Modular Angle Holder Eco	85369090	43.00	20/480
PEARL LAMP BATTEN HOLDERS				
LR 1032	Pearl Batten Holder Eco	85369090	53.00	20/480
LR 1034	Pearl Batten Holder Red	85369090	58.00	20/480
LR 1035	Pearl Batten Holder Orange	85369090	58.00	20/480
MARVEL LAMP BATTEN HOLDERS				
LR 1041	Marvel Batten Holder	85369090	56.00	20/480
LR 1042	Marvel Batten Holder Eco	85369090	51.00	20/480
VENUS LAMP BATTEN HOLDERS				
LR 1045	Venus Batten Holder	85369090	51.00	20/480
LR 1046	Venus Batten Holder Eco	85369090	46.00	20/480
POLO MODULAR LAMP BATTEN HOLDERS				
LR 1048	Polo Modular Batten Holder	85369090	49.00	20/480
LR 1049	Polo Modular Batten Holder Eco	85369090	43.00	20/480



CODE	PRODUCT	HSN CODE	MRP ₹	STD/MST PKG.
PLATE TYPE LAMP ANGLE HOLDERS				
LR 1051	Prime Angle Holder Plate Type (4.5"x4.5")	85369090	93.00	10/240
LR 1052	Prime Angle Holder Plate Type Eco (4.5"x4.5")	85369090	88.00	10/240
LR 1053	Universal Angle Holder Plate Type (4"x4")	85369090	87.00	10/240
LR 1054	Royal Angle Holder Plate Type (4"x4")	85369090	84.00	10/240
LR 1055	Atlas Angle Holder Plate Type (4.5"x4.5")	85369090	89.00	10/240
PLATE TYPE LAMP BATTEN HOLDERS				
LR 1061	Prime Batten Holder Plate Type (4.5"x4.5")	85369090	93.00	10/240
LR 1062	Prime Batten Holder Plate Type Eco (4.5"x4.5")	85369090	88.00	10/240
LR 1063	Universal Batten Holder Plate Type (4"x4")	85369090	87.00	10/240
LR 1064	Royal Batten Holder Plate Type (4"x4")	85369090	84.00	10/240
LR 1065	Atlas Batten Holder Plate Type (4.5"x4.5")	85369090	89.00	10/240
PENDANT HOLDERS / ADAPTORS				
LR 1071	Delux Pendant Holder Eco	85369090	39.00	30/720
LR 1072	Ruby Pendant Holder Eco	85369090	39.00	30/1440
LR 1073	Delux Pendant Holder (Metal Ring)	85369090	41.00	30/720
LR 1074	Ruby Pendant Holder (Metal Ring)	85369090	41.00	30/1440
LR 1079	Leo Adaptor	85369090	34.00	30/1440



CODE	PRODUCT	HSN CODE	MRP ₹	STD/ MST PKG.
CEILING ROSE				
LR 1081	Star Ceiling Rose - with 2 Parts	85369090	43.00	30/720
LR 1082	Star Ceiling Rose - with 3 Parts	85369090	50.00	30/720
LR 1086	Star Ceiling Rose Plate Type (4.5"x4.5") - with 2 Parts	85369090	69.00	30/720
LR 1087	Star Ceiling Rose Plate Type (4.5"x4.5") - with 3 Parts	85369090	75.00	30/720
LR 1096	Star Mini Ceiling Rose Plate Type (4"x4") - with 2 Parts	85369090	64.00	30/720
LR 1097	Star Mini Ceiling Rose Plate Type (4"x4") - with 3 Parts	85369090	69.00	30/720
LR 1106	Sky Ceiling Rose - with 2 Parts	85369090	38.00	30/720
LR 1107	Sky Ceiling Rose - with 3 Parts	85369090	43.00	30/720
2 PIN PLUG, 2 PIN PLUG SOCKET				
LR 2001	Jewel 2 Pin Plug (White / Orange)	85369090	25.00	40/1920
LR 2002	Jewel 2 Pin Plug Socket Assembly (White / Orange)	85369090	48.00	40/1920
LR 2003	Jewel 2 Pin Socket (White / Orange)	85369090	24.00	40/1920
LR 2004	Diamond 2 Pin Plug	85369090	29.00	40/1920
LR 2005	Diamond 2 Pin Plug Socket Assembly	85369090	53.00	40/1920
LR 2006	Diamond 2 Pin Socket	85369090	25.00	40/1920
(AVAILABLE WITH BOTH 19.00MM & 16.50MM CENTRE)				
PLUG TOPS				
LR 2011	Magna 6 Amp 3 Pin Plug Top (PC)	85369090	79.00	20/800
LR 2012	Magna 16 Amp 3 Pin Plug Top (PC)	85369090	123.00	20/480
LR 2013	Maximo 6 Amp 3 Pin Plug Top (PC)	85369090	79.00	20/800
LR 2014	Maximo 16 Amp 3 Pin Plug Top (PC)	85369090	123.00	20/480



CODE	PRODUCT	HSN CODE	MRP ₹	STD/ MST PKG.
MULTI PLUGS & TRAVEL SOCKETS				
LR 2051	CRYSTAL 6A. 3 Pin Uni. Travel Multi Plug with Indicator (BOX PACK)	85369090	154.00	20/480
LR 2052	CRYSTAL 6A. 3 Pin Uni. Travel Multi Plug with Indicator (BLISTER PACK)	85369090	165.00	15/360
LR 2061	OPAL 6A. 3 Pin Uni. Travel Multi Plug Adaptor (BOX PACK)	85369090	115.00	20/480
LR 2062	OPAL 6A. 3 Pin Uni. Travel Multi Plug Adaptor (BLISTER PACK)	85369090	126.00	15/360
LR 2071	EMERALD 6A. 3 Pin Uni. Travel Multi Plug with Indicator (BOX PACK)	85369090	149.00	20/480
LR 2072	EMERALD 6A. 3 Pin Uni. Travel Multi Plug with Indicator (BLISTER PACK)	85369090	159.00	15/360
LR 2081	TOPAZ 6A. 3 Pin Multi Plug Adaptor (BOX PACK)	85369090	99.00	20/480
LR 2082	TOPAZ 6A. 3 Pin Multi Plug Adaptor (BLISTER PACK)	85369090	115.00	15/360
LR 2091	CRYSTAL UK Series 13A. 3 Pin Uni. Travel Multi Plug Adaptor with Indicator (BOX PACK)	85369090	199.00	20/480
LR 2092	CRYSTAL UK Series 13A. 3 Pin Uni. Travel Multi Plug Adaptor with Indicator (BLISTER PACK)	85369090	218.00	15/360
LR 2101	GEM 6/16A. 3 Pin Uni. Multi Plug Adaptor / Converter (BOX PACK)	85369090	176.00	20/400
LR 2102	GEM 6/16A. 3 Pin Uni. Multi Plug Adaptor / Converter (BLISTER PACK)	85369090	202.00	15/360



Jesus
LR 3001



Lord Ganesha
LR 3002



Lord Laxmi
LR 3003



Bal Krishna
LR 3004



Holy Mecca
LR 3005



Tirupathi Balaji
LR 3006



Saibaba
LR 3007



Gurunanak
LR 3008



LR 3011



LR 3012



LR 3013



LR 3014



LR 3031 / 3032 / 3033 / 3034 / 3035 / 3036



LR 3201



LR 3251



LR 3252

CODE	PRODUCT	HSN CODE	MRP ₹	STD/ MST PKG.
HOLY - NIGHT LAMPS				
LR 3001	Holy - Jesus	94051020	177.00	10/160
LR 3002	Holy - Ganesha	94051020	177.00	10/160
LR 3003	Holy - Laxmi	94051020	177.00	10/160
LR 3004	Holy - Bal Krishna	94051020	177.00	10/160
LR 3005	Holy - Mecca	94051020	177.00	10/160
LR 3006	Holy - Tirupathi Balaji	94051020	177.00	10/160
LR 3007	Holy - Saibaba	94051020	177.00	10/160
LR 3008	Holy - Gurunanak	94051020	177.00	10/160
SIDE GLOW NIGHT LAMPS				
LR 3011	Side Glow - Blue Moon	94051020	158.00	10/160
LR 3012	Side Glow - Sunset	94051020	158.00	10/160
LR 3013	Side Glow - Aqua Green	94051020	158.00	10/160
LR 3014	Side Glow - Warm White	94051020	158.00	10/160
FOOT LIGHT (3M PLATE)				
LR 3031	Elumi Foot Light- Warm White ●	94051020	194.00	10/160
LR 3032	Elumi Foot Light- Cool Light ○	94051020	194.00	10/160
LR 3033	Elumi Foot Light- Blue Moon ●	94051020	194.00	10/160
LR 3034	Elumi Foot Light- Baby Pink ●	94051020	194.00	10/160
LR 3035	Elumi Foot Light- Nature Green ●	94051020	194.00	10/160
LR 3036	Elumi Foot Light- Crimson Red ●	94051020	194.00	10/160
DOOR BELLS & MORE				
LR 3201	Ripple Stereo Ding Dong Bell	85318000	423.00	5/60
LR 3251	Ripple Mini Ding Dong Bell	85318000	262.00	10/120
LR 3252	Cube Ding Dong Bell	85318000	262.00	10/120



LR 4001 / 4002 / 4003 / 4004 / 4009



LR 4010 / 4011 / 4019



LR 4020 / 4021 / 4022 / 4029



LR 4030 / 4031 / 4032 / 4039

CODE	PRODUCT	HSN CODE	MRP ₹	STD/MST PKG.
POWER STRIPS				
LR 4001	Universal 4+1 Power strip 2 Mtr. 4 Intl. Socket, Master Switch & Indicator (BOX PACK)	85371000	599.00	5/60
LR 4002	Universal 4+1 Power strip 3 Mtr. 4 Intl. Socket, Master Switch & Indicator (BOX PACK)	85371000	710.00	5/60
LR 4003	Universal 4+1 Power strip 5 Mtr. 4 Intl. Socket, Master Switch & Indicator (BOX PACK)	85371000	849.00	5/60
LR 4004	Universal 4+1 Power strip 8 Mtr. 4 Intl. Socket, Master Switch & Indicator (BOX PACK)	85371000	1124.00	5/60
LR 4009	Universal 4+1 Power strip 2 Mtr. 4 Intl. Socket, Master Switch & Indicator (BLISTER PACK)	85371000	645.00	5/60
LR 4010	SLEEK 4+1 Power strip 2 Mtr. 4 Intl. Socket, Master Switch & Indicator (BOX PACK)	85371000	556.00	5/60
LR 4011	SLEEK 4+1 Power strip 5 Mtr. 4 Intl. Socket, Master Switch & Indicator (BOX PACK)	85371000	822.00	5/40
LR 4019	SLEEK 4+1 Power strip 2 Mtr. 4 Intl. Socket, Master Switch & Indicator (BLISTER PACK)	85371000	599.00	5/60
LR 4020	ONYX 4+1 Power strip 2 Mtr. 4 Intl. Socket, Master Switch with Indicator (BOX PACK)	85371000	636.00	5/60
LR 4021	ONYX 4+1 Power strip 5 Mtr. 4 Intl. Socket, Master Switch with Indicator (BOX PACK)	85371000	903.00	5/40
LR 4022	ONYX 4+1 Power strip 8 Mtr. 4 Intl. Socket, Master Switch with Indicator (BOX PACK)	85371000	1182.00	5/40
LR 4029	ONYX 4+1 Power strip 2 Mtr. 4 Intl. Socket, Master Switch with Indicator (BLISTER PACK)	85371000	699.00	5/60
LR 4030	ONYX 4+1 Power strip 2 Mtr. 4 Intl. Socket, Master Switch with Indicator & Thermal Tripper (BOX PACK)	85371000	712.00	5/60
LR 4031	ONYX 4+1 Power strip 5 Mtr. 4 Intl. Socket, Master Switch with Indicator & Thermal Tripper (BOX PACK)	85371000	964.00	5/40
LR 4032	ONYX 4+1 Power strip 8 Mtr. 4 Intl. Socket, Master Switch with Indicator & Thermal Tripper (BOX PACK)	85371000	1248.00	5/40
LR 4039	ONYX 4+1 Power strip 2 Mtr. 4 Intl. Socket, Master Switch with Indicator & Thermal Tripper (BLISTER PACK)	85371000	762.00	5/60



LR 4040 / 4041 / 4042 / 4049



LR 4050 / 4051 / 4052 / 4059



LR 4060 / 4061 / 4062 / 4069

CODE	PRODUCT	HSN CODE	MRP ₹	STD/MST PKG.
POWER STRIP				
LR 4040	ONYX 4+4 Power Strip 2 Mtr. 4 International Socket, 4 Individual Switch with Indicator (BOX PACK)	85371000	819.00	5/60
LR 4041	ONYX 4+4 Power Strip 5 Mtr. 4 International Socket, 4 Individual Switch with Indicator (BOX PACK)	85371000	1078.00	5/40
LR 4042	ONYX 4+4 Power Strip 8 Mtr. 4 International Socket, 4 Individual Switch with Indicator (BOX PACK)	85371000	1352.00	5/40
LR 4049	ONYX 4+4 Power Strip 2 Mtr. 4 International Socket, 4 Individual Switch with Indicator (BLISTER PACK)	85371000	840.00	5/60
LR 4050	ONYX 4+4 Power Strip 2 Mtr. 4 International Socket, 4 Individual Switch with Indicator & Thermal Tripper (BOX PACK)	85371000	886.00	5/60
LR 4051	ONYX 4+4 Power Strip 5 Mtr. 4 International Socket, 4 Individual Switch with Indicator & Thermal Tripper (BOX PACK)	85371000	1125.00	5/40
LR 4052	ONYX 4+4 Power Strip 8 Mtr. 4 International Socket, 4 Individual Switch with Indicator & Thermal Tripper (BOX PACK)	85371000	1408.00	5/40
LR 4059	ONYX 4+4 Power Strip 2 Mtr. 4 International Socket, 4 Individual Switch with Indicator & Thermal Tripper (BLISTER PACK)	85371000	899.00	5/60
LR 4060	ONYX PLUS 6+1 Power Strip 2 Mtr. 6 International Socket, Master Switch with Indicator & Thermal Tripper (BOX PACK)	85371000	874.00	5/40
LR 4061	ONYX PLUS 6+1 Power Strip 5 Mtr. 6 International Socket, Master Switch with Indicator & Thermal Tripper (BOX PACK)	85371000	1091.00	5/40
LR 4062	ONYX PLUS 6+1 Power Strip 8 Mtr. 6 International Socket, Master Switch with Indicator & Thermal Tripper (BOX PACK)	85371000	1373.00	5/40
LR 4069	ONYX PLUS 6+1 Power Strip 2 Mtr. 6 International Socket, Master Switch with Indicator & Thermal Tripper (BLISTER PACK)	85371000	930.00	5/40



CODE	PRODUCT	HSN CODE	MRP ₹	STD/MST PKG.
TURBO POWER STRIP 6/16A (HEAVY DUTY)				
LR 4100	TURBO TWIN S.S. Combined 6-16A Heavy Duty Power Strip With Connector (BOX PACK)	85366990	610.00	5/60
LR 4101	TURBO TWIN S.S. Combined 2 Mtr. 6-16A Heavy Duty Power Strip Cord Wire (BOX PACK)	85366990	727.00	5/40
ALPHA SS COMBINED 6/16A (HEAVY DUTY)				
LR 4151	ALPHA 3 in 1 S.S. Combined 6-16A Heavy Duty With Box (BOX PACK)	85366990	283.00	5/120
LR 4152	ALPHA 3 in 1 S.S. Combined Top 6-16A Heavy Duty (BOX PACK)	85366990	231.00	5/120
LR 4161	ALPHA Plus S.S. Combined Twin 6-16A (BOX PACK)	85366990	428.00	5/60
SPIKE GUARDS				
LR 4250	ONYX 4+1 Spike Guard 2 Mtr. 4 International Socket, Master Switch with Indicator, Thermal Tripper & Surge Protector (BOX PACK)	85371000	814.00	5/60
LR 4251	ONYX 4+1 Spike Guard 5 Mtr. 4 International Socket, Master Switch with Indicator, Thermal Tripper & Surge Protector (BOX PACK)	85371000	1067.00	5/40
LR 4252	ONYX 4+1 Spike Guard 8 Mtr. 4 International Socket, Master Switch with Indicator, Thermal Tripper & Surge Protector (BOX PACK)	85371000	1331.00	5/40
LR 4259	ONYX 4+1 Spike Guard 2 Mtr. 4 International Socket, Master Switch with Indicator, Thermal Tripper & Surge Protector (BLISTER PACK)	85371000	837.00	5/60
LR 4260	ONYX 4+4 Spike Guard 2 Mtr. 4 International Socket, 4 Individual Switch with Indicator, Thermal Tripper & Surge Protector (BOX PACK)	85371000	1005.00	5/60
LR 4269	ONYX 4+4 Spike Guard 2 Mtr. 4 International Socket, 4 Individual Switch with Indicator, Thermal Tripper & Surge Protector (BLISTER PACK)	85371000	1022.00	5/60

CODE

PRODUCT

HSN
CODE

MRP
₹

STD/
MST
PKG.

SPIKE GUARDS

LR 4350	ONYX PLUS 6+1 Spike Guard 2 Mtr. 6 International Socket, Master Switch with Indicator, Thermal Tripper & Surge Protector (BOX PACK)	85371000	934.00	5/40
LR 4351	ONYX PLUS 6+1 Spike Guard 5 Mtr. 6 International Socket, Master Switch with Indicator, Thermal Tripper & Surge Protector (BOX PACK)	85371000	1166.00	5/40
LR 4352	ONYX PLUS 6+1 Spike Guard 8 Mtr. 6 International Socket, Master Switch with Indicator, Thermal Tripper & Surge Protector (BOX PACK)	85371000	1449.00	5/40
LR 4359	ONYX PLUS 6+1 Spike Guard 2 Mtr. 6 International Socket, Master Switch with Indicator, Thermal Tripper & Surge Protector (BLISTER PACK)	85371000	992.00	5/40

SPIKE GUARDS WITH USB

LR 4450	ONYX 3+4+2 Spike Guard 2 Mtr. 3 International Socket, 4 Individual Switch with Indicator, Thermal Tripper, Twin USB Port (Type 'A' & Type 'C') & Surge Protector (BOX PACK)	85371000	1426.00	5/60
LR 4459	ONYX 3+4+2 Spike Guard 2 Mtr. 3 International Socket, 4 Individual Switch with Indicator, Thermal Tripper, Twin USB Port (Type 'A' & Type 'C') & Surge Protector (BLISTER PACK)	85371000	1470.00	5/60
LR 4460	ONYX PLUS 5+1+2 Spike Guard 2 Mtr. 5 International Socket, Master Switch with Indicator, Thermal Tripper, Twin USB Port (Type 'A' & Type 'C') & Surge Protector (BOX PACK)	85371000	1383.00	5/40
LR 4469	ONYX PLUS 5+1+2 Spike Guard 2 Mtr. 5 International Socket, Master Switch with Indicator, Thermal Tripper, Twin USB Port (Type 'A' & Type 'C') & Surge Protector (BLISTER PACK)	85371000	1423.00	5/40

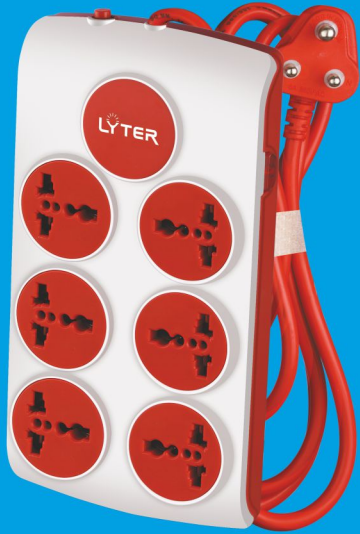

LR 4350 / 4351 / 4352 / 4359



LR 4450 / 4459



LR 4460 / 4469

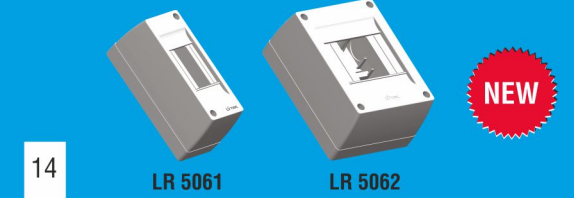
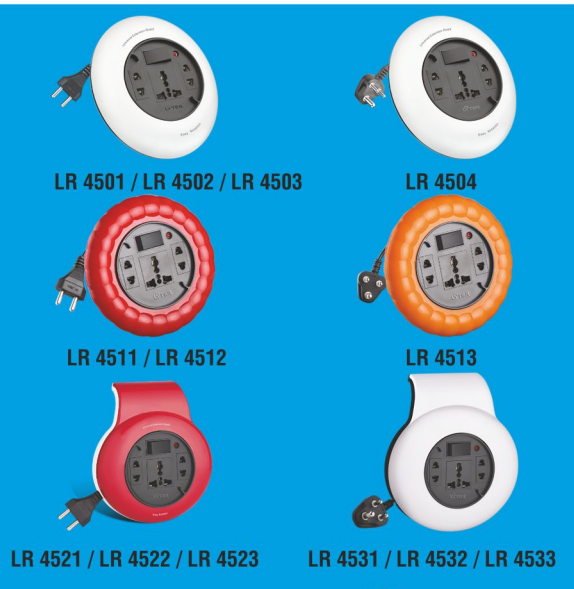

CODE	PRODUCT	HSN CODE	MRP ₹	STD/MST PKG.
EXTENSION CORDS				
LR 4501	Oval Extension Cord (2 Pin 5 Mtr)	85371000	404.00	5/60
LR 4502	Oval Extension Cord (2 Pin 4 Mtr)	85371000	387.00	5/60
LR 4503	Oval Extension Cord (2 Pin 8 Mtr)	85371000	478.00	5/60
LR 4504	Oval Extension Cord (3 Pin 4 Mtr)	85371000	471.00	5/60
LR 4511	Pumpkin Extension Cord (2 Pin 4 Mtr)	85371000	360.00	5/60
LR 4512	Pumpkin Extension Cord (2 Pin 7 Mtr)	85371000	429.00	5/60
LR 4513	Pumpkin Extension Cord (3 Pin 3 Mtr)	85371000	422.00	5/60
LR 4521	Shell Mini Extension Cord (2 Pin 4 Mtr)	85371000	399.00	5/60
LR 4522	Shell Mini Extension Cord (2 Pin 5 Mtr)	85371000	411.00	5/60
LR 4523	Shell Mini Extension Cord (3 Pin 3 Mtr)	85371000	449.00	5/60
LR 4531	Shell Plus Extension Cord (2 Pin 10 Mtr)	85371000	536.00	5/60
LR 4532	Shell Plus Extension Cord (2 Pin 7 Mtr)	85371000	476.00	5/60
LR 4533	Shell Plus Extension Cord (3 Pin 5 Mtr)	85371000	529.00	5/60
CABLES & CORDS				
LR 4580	6A Cord with Moulded Plug Top 5 Mtr	85441920	499.00	1/60
LR 4581	6A Cord with Moulded Plug Top 8 Mtr	85441920	798.00	1/60
LR 4582	16A Cord with Moulded Plug Top 5 Mtr	85441920	839.00	1/60
LR 4583	16A Cord with Moulded Plug Top 8 Mtr	85441920	1198.00	1/60
WOOD PLATES				
LR 5001	L-Wood Plate (4.5"x4.5" 116mm x 116mm)	85441920	49.00	10/480
LR 5002	L-Wood Plate (4.5"x6.5" 171mm x 116mm)	85441920	66.00	10/480
LR 5003	L-Wood Plate (4.5"x8.5" 216mm x 116mm)	85441920	94.00	10/240
LR 5004	L-Wood Plate (4.5"x10.5" 267mm x 116mm)	85441920	132.00	10/240
LR 5005	L-Wood Plate (4.5"x12.5" 317mm x 116mm)	85441920	139.00	10/240
ROUND CEILING PLATES				
LR 5021	Round Junction Plate (Dummy - Size - 3.5")	85389000	9.50	50/2400
LR 5022	Round Junction Plate (Size - 3.5")	85389000	9.50	50/2400
LR 5023	Medium Junction Plate (Size - 4.25")	85389000	13.50	50/2400
LR 5024	Fan Junction Plate (Size - 6.5")	85389000	36.00	50/900
SQUARE BOX				
LR 5041	KING Square Box (Size - 3" x 3")	85389000	15.00	40/1440
SECURA TERMINAL BLOCK				
LR 5050	SECURA Terminal Block 16A 3 Way With Cover	85367000	78.00	40/960
LR 5051	SECURA Terminal Block 16A 3 Way Without Cover	85367000	74.00	40/960
MCB ENCLOSURE				
LR 5061	SAFEON 1-2 Pole MCB Enclosure	85389090	68.00	15/360
LR 5062	SAFEON 3-4 Pole MCB Enclosure	85389090	99.00	10/240



LYTER®

The Ultimate Choice

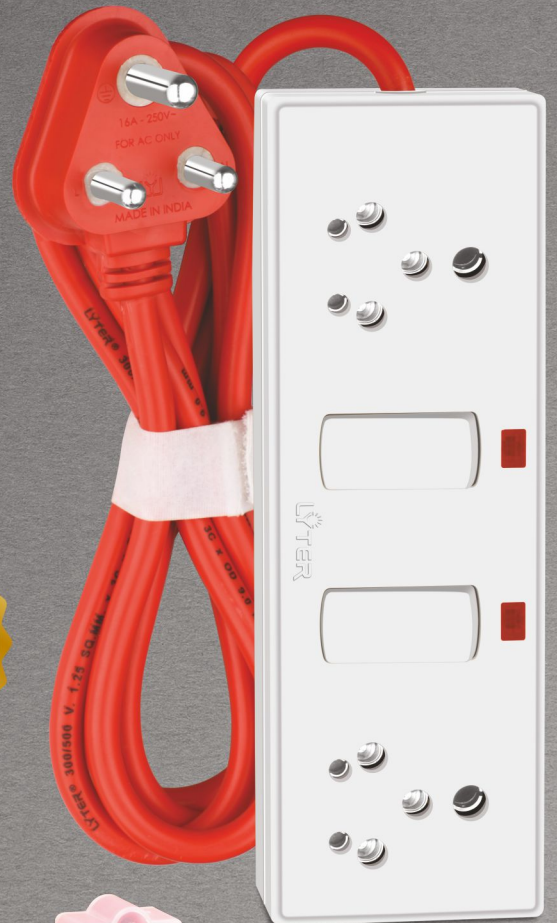
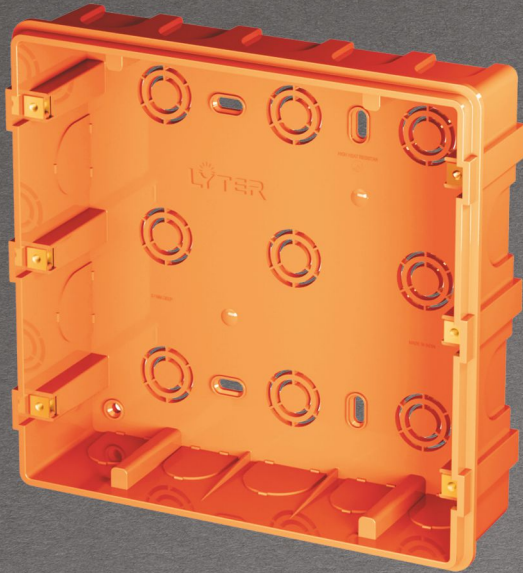
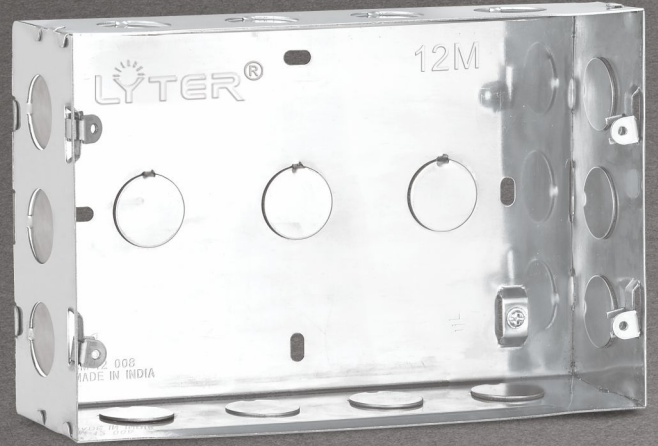
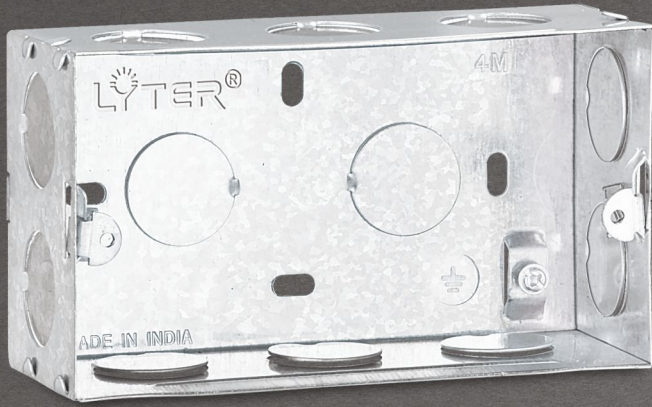

★ ★ ★ ★ ★
**HEAVY DUTY
BRASS PARTS
USED FOR
CARRYING
CURRENT**



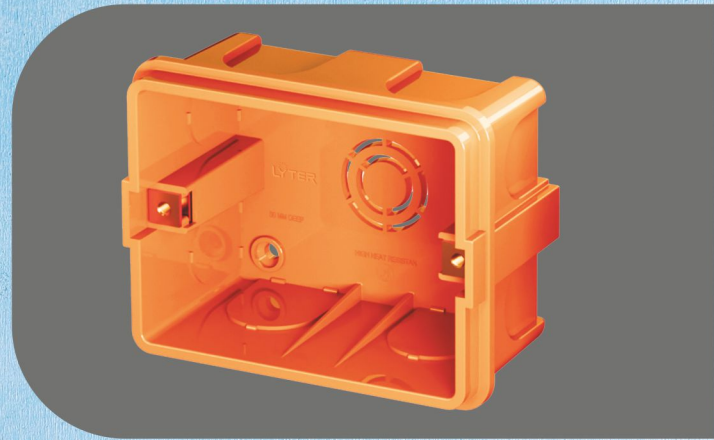

FLUSH MOUNTING PLASTIC GANG BOXES

Concealed boxes are simple enclosures used to create mounting support and enclose wiring system. These are different from surface boxes in their application: they are concealed inside a wall. Their function is to protect the enclosed wiring from moisture, heat, corrosion etc. and to give them a long service life.

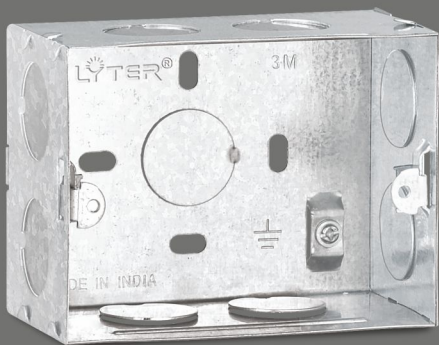

FLUSH MOUNTING METAL GANG BOXES (GALVANISED - GI) FLOWER MODEL

The Galvanised Mounting Flower Project Model Boxes are specially designed and made by alloy of various metals of steel to prevent it from rusting; thus making the boxes a long life while being concealed inside the wall.

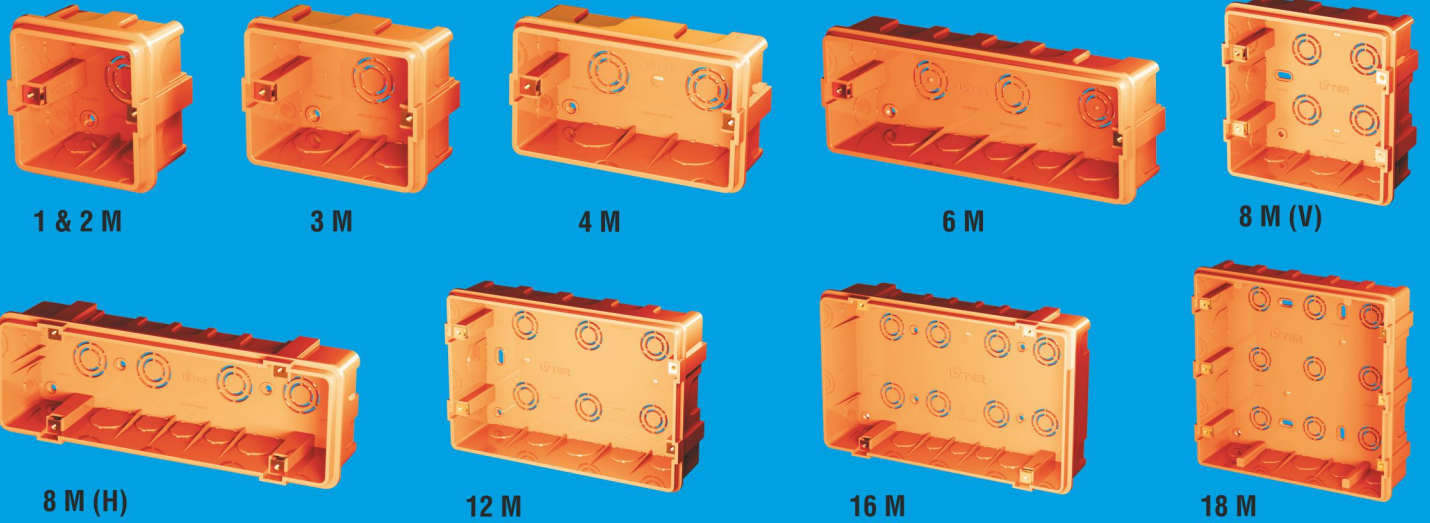

HORIZON FLUSH MOUNTING PLASTIC GANG BOXES (PLASTIC)

MODULE	1 & 2 M	3 M	4 M	6 M	8M (H)	8M (V)	12 M	16 M	18 M
Code	LR 5101	LR 5102	LR 5103	LR 5104	LR 5105	LR 5106	LR 5107	LR 5108	LR 5109
MRP ₹	70.00	81.00	97.00	128.00	150.00	150.00	205.00	241.00	290.00
Size in WxHxL (mm)	81x84x58	106x84x58	141x84x58	215x84x58	243x84x58	141x141x58	215x144x58	245x153x63	215x215x63
STD/MST/PKG.	10/300	10/300	10/300	5/300	10/120	5/60	5/40	5/60	5/60

HSN CODE : 85381010



FLUSH MOUNTING METAL GANG BOXES (GALVANISED - GI) FLOWER MODEL

MODULE	1 & 2 M	3 M	4 M	6 M	8M (H)	8M (V)	12 M	16 M	18 M
Code	LR 5151	LR 5152	LR 5153	LR 5154	LR 5155	LR 5156	LR 5157	LR 5158	LR 5159
MRP ₹	71.00	94.00	113.00	138.00	184.00	184.00	243.00	295.00	340.00
Size in WxHxL (mm)	81x84x58	106x84x58	141x84x58	215x84x58	243x84x58	141x141x58	215x144x58	245x153x63	215x215x63
STD/MST/PKG.	10/300	10/300	10/300	5/300	5/100	5/100	5/60	5/60	5/60

HSN CODE : 85381090

GPSP 52 mm Deep



**FLUSH MOUNTING METAL GANG BOXES
(GALVANISED - GI) SKIN PASS FINISH**

The Galvanised Mounting Skin Pass Finish Boxes are specially designed and pressed by applying protective zinc coating on steel with a smooth finish to prevent it from rusting; resulting the boxes to stay corrosion free application to give it an extended life.

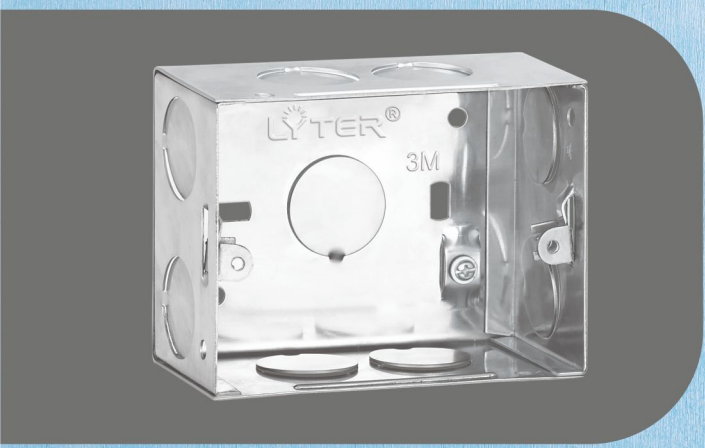

**FLUSH MOUNTING METAL GANG BOXES
(STAINLESS STEEL - SS)**

The Stainless Steel Mounting boxes are an alloy of iron that is resistant to rusting and corrosion; it contains elements such as carbon, chromium, other non metals and metals to obtain the desired properties to keep away moisture and heat. Hence, giving it more Shine, long & durable life.



1 & 2 M



3 M



4 M



6 M



8 M (V)



8 M (H)



12 M



16 M



18 M

FLUSH MOUNTING METAL GANG BOXES (GALVANISED - GI) SKIN PASS FINISH

MODULE	1 & 2 M	3 M	4 M	6 M	8M (H)	8M (V)	12 M	16 M	18 M
Code	LR 5176	LR 5177	LR 5178	LR 5179	LR 5180	LR 5181	LR 5182	LR 5183	LR 5184
MRP ₹	83.00	110.00	134.00	162.00	216.00	216.00	264.00	330.00	376.00
Size in WxHxL (mm)	81x84x58	106x84x58	141x84x58	215x84x58	243x84x58	141x141x58	215x144x58	245x153x63	215x215x63
STD/MST/PKG.	10/300	10/300	10/300	5/300	5/100	5/100	5/60	5/60	5/60

HSN CODE : 85381090



1 & 2 M



3 M



4 M



6 M



8 M (V)



8 M (H)



12 M



16 M



18 M

FLUSH MOUNTING METAL GANG BOXES (STAINLESS STEEL - SS)

MODULE	1 & 2 M	3 M	4 M	6 M	8M (H)	8M (V)	12 M	16 M	18 M
Code	LR 5201	LR 5202	LR 5203	LR 5204	LR 5205	LR 5206	LR 5207	LR 5208	LR 5209
MRP ₹	122.00	145.00	173.00	233.00	255.00	255.00	370.00	410.00	472.00
Size in WxHxL (mm)	81x84x58	106x84x58	141x84x58	215x84x58	243x84x58	141x141x58	215x144x58	245x153x63	215x215x63
STD/MST/PKG.	10/300	10/300	10/300	5/300	5/100	5/100	5/60	5/60	5/60

HSN CODE : 85381090

SS 202 / 52 mm Deep / 0.8 mm Thickness Body & Collar 0.6 mm Thickness



LYTER[®]
The Ultimate Choice

PRECISION MOULDS & MOULDINGS
Plot No. R-257, TTC Industrial Area,
Thane-Belapur Road, MIDC Rabale,
Navi Mumbai - 400 701.
Customer Care / Whatsapp: +91 98 33 623 624
E-Mail : info@lyterworld.com / sales@lyterworld.com

Authorised Distributor / Dealer.....

Follow Us @thelyterworld



 www.lyterworld.com